

Article number: 20615239

Description: E+G Indexing lever
GN 215-60-K16-A

Measures

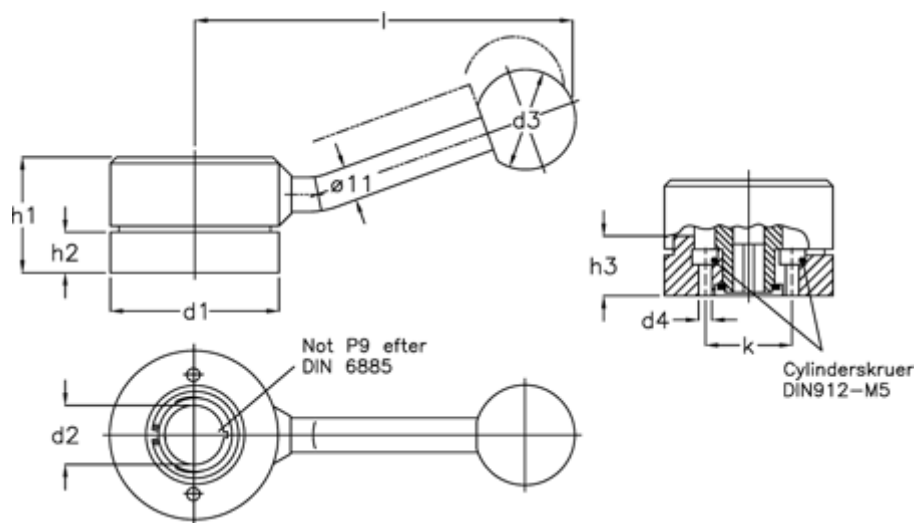

$d1 = 60$	K	= 36
$d2 = K16$	Length l	= 125
$d3 = 32$	W	= 19°
$d4 = 5.2$		
$d5 = 50.0$		
$h1 = 39$		
$h2 = 15$		
$h3 = 18.5$		